

F2003 Series User Manual	Documentation No.	Product Version	Page
	Product Name:		Total:

F2003 Series User Manual

The user manual is suitable for the following model:

Model	Product Type
F2003	GSM IP MODEM



Xiamen Four-Faith Communication Technology Co., Ltd.

Add: J1-J3,3rd Floor,No.44,GuanRi Road,SoftWare

Park,XiaMen,China Zip Code:361008

Tel: +86 592-6300326 , 6300325, 6300324

Fax:+86 592-5912735

<http://www.fourfaith.com>



Files Revised Record

Date	Version	Remark	Author

Copyright Notice

All contents in the files are protected by copyright law, and all copyrights are reserved by Xiamen Four-Faith Communication Technology Co., Ltd. Without written permission, all commercial use of the files from Four-Faith are forbidden, such as copy, distribute, reproduce the files, etc., but non-commercial purpose, downloaded or printed by individual (all files shall be not revised, and the copyright and other proprietorship notice shall be reserved) are welcome.

Trademark Notice

Four-Faith、四信、、、 are all registered trademarks of Xiamen Four-Faith Communication Technology Co., Ltd., illegal use of the name of Four-Faith, trademarks and other marks of Four-Faith is forbidden, unless written permission is authorized in advance.



Contents

Chapter 1 Brief Introduction of Product	6
1.1 General	6
1.2 Features and Benefits	6
1.3 Working Principle	7
1.4 Specifications	7
Chapter 2 Installation Introduction	10
2.1 General	10
2.2 Encasement List	10
2.3 Installation and Cable Connection	10
2.4 Power	12
2.5 Indicator Lights Introduction	13
Chapter 3 Configuration.....	14
3.1 Configuration Connection	14
3.2 Enter Configure State	14
3.3 Configuration	15
3.3.1 Serial Port Parameters	15
3.3.2 Workmode	16
3.3.3 HEX SMS	17
3.3.4 Peer Phone.....	18
3.3.5 SMS Center	18
3.3.6 Debug Level	18
3.3.7 Retry Times	19
3.3.8 Bytes Interval	19
Appendix.....	20

Chapter 1 Brief Introduction of Product

1.1 General

F2003 GSM IP MODEM is a kind of cellular terminal device that provides SMS and CSD function by public GSM network.

It adopts high-powered industrial 16/32 bits CPU and embedded real time operating system. It supports RS232 and RS485 (or RS422) port that can conveniently and transparently connect one device to a cellular network, allowing you to connect to your existing serial devices with only basic configuration.

It has been widely used on M2M fields, such as intelligent transportation, smart grid, industrial automation, telemetry, finance, POS, water supply, environment protection, post, weather, and so on.

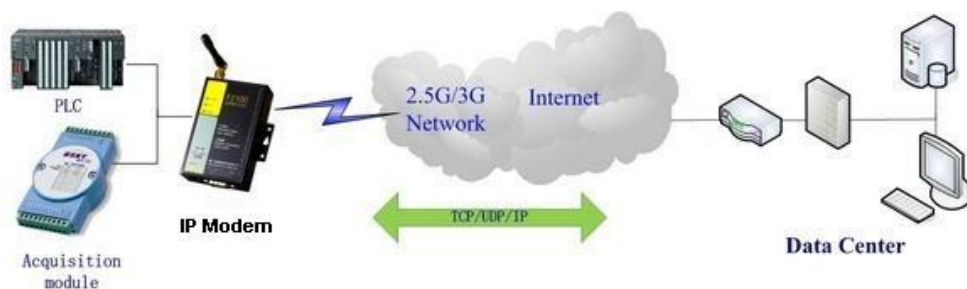

1.2 Features and Benefits

Design for Industrial Application

- ◆ High-powered industrial cellular module
- ◆ High-powered industrial 16/32 bits CPU
- ◆ Support low-consumption mode, including sleep mode, scheduled online/offline mode, scheduled power-on/power-off mode(optional)
- ◆ Housing: iron, providing IP30 protection.
- ◆ Power range: DC 5~35V

Stability and Reliability

- ◆ Support hardware and software WDT
- ◆ Support auto recovery mechanism, including online detect, auto redial when offline to make it always online
- ◆ RS232/RS485/RS422 port: 15KV ESD protection
- ◆ SIM/UIM port: 15KV ESD protection
- ◆ Power port: reverse-voltage and overvoltage protection
- ◆ Antenna port: lightning protection(optional)

Xiamen Four-Faith Communication Technology Co.,Ltd.

Page 6 of 22

Add: J1-J3,3rdFloor,No.44,GuanRiRoad,SoftWare Park,XiaMen .361008.China

http: //www.fourfaith.com Tel: +86 592-6300326 6300325 6300324 Fax: +86 592-5912735

Standard and Convenience

- ◆ Support standard RS232 and RS485(or RS422) port that can connect to serial devices directly
- ◆ Support intellectual mode, enter into communication state automatically when powered
- ◆ Support several work modes
- ◆ Convenient configuration and maintenance interface

High-performance

- ◆ Support transparent SMS data transfer
- ◆ Send SMS to up to 5 mobile numbers at the same time
- ◆ Support server and client functions
- ◆ Support CSD function

1.3 Working Principle

The principle chart of the IP MODEM is as following:

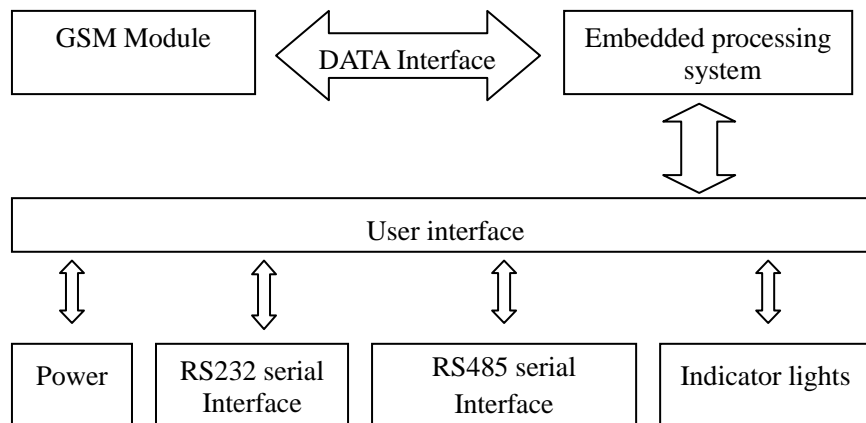

1.4 Specifications

Cellular Specification

Item	Content
Cellular Module	Industrial cellular module
Standard and Band	EGSM900/GSM1800MHz, GSM850/900/1800/1900MHz(optional) Compliant to GSM phase 2/2+
Bandwidth	14.4Kbps CSD
TX power	GSM850/900: <33dBm GSM1800/1900: <30dBm
RX sensitivity	<-107dBm

Hardware System

Item	Content
------	---------

[Xiamen Four-Faith Communication Technology Co.,Ltd.](http://www.fourfaith.com)

Page 7 of 22

Add: J1-J3,3rdFloor,No.44,GuanRiRoad,SoftWare Park,XiaMen .361008.China

http: //www.fourfaith.com Tel: +86 592-6300326 6300325 6300324 Fax: +86 592-5912735

CPU	Industrial 16/32 bits CPU
FLASH	1MB(Extendable)
SRAM	512KB(Extendable)

Interface Type

Item	Content
Serial	1 RS232 port and 1 RS485(orRS422) port, 15KV ESD protection Data bits: 5, 6, 7, 8 Stop bits: 1, 1.5, 2 Parity: none, even, odd, space, mark Baud rate: 110~230400 bps
Indicator	"Power", "ACT", "Online"
Antenna	Standard SMA female interface, 50 ohm, lightning protection(optional)
SIM/UIM	Standard 3V/1.8V user card interface, 15KV ESD protection
Power	Standard 3-PIN power jack, reverse-voltage and overvoltage protection

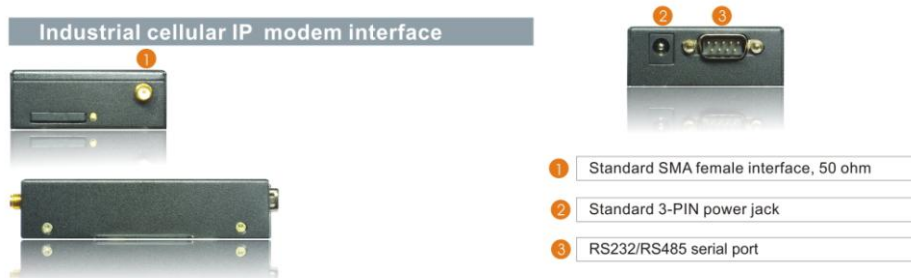

Power Input

Item	Content
Standard Power	DC 12V/0.5A
Power Range	DC 5~35V
Consumption	<250mA (12V)

Physical Characteristics

Item	Content
Housing	Iron, providing IP30 protection
Dimensions	91x58.5x22 mm
Weight	205g

Environmental Limits

Item	Content
Operating Temperature	-25~+65 ℃ (-13~+149°F)
Extended Operating Temperature	-30~+75 ℃ (-22~+167°F)

Storage Temperature	-40~+85 ℃ (-40~+185°F)
Operating Humidity	95% (Non-condensing)

Chapter 2 Installation Introduction

2.1 General

The IP MODEM must be installed correctly to make it work properly.

Warning: Forbid to install the IP MODEM when powered!

2.2 Encasement List

Name	Quantity	Remark
IP MODEM host	1	
Antenna	1	
Power adapter	1	
RS232 data cable	1	optional
RS485 data cable	1	optional
Manual CD	1	
Certification card	1	
Maintenance card	1	

2.3 Installation and Cable Connection

Dimension: (unit: mm)

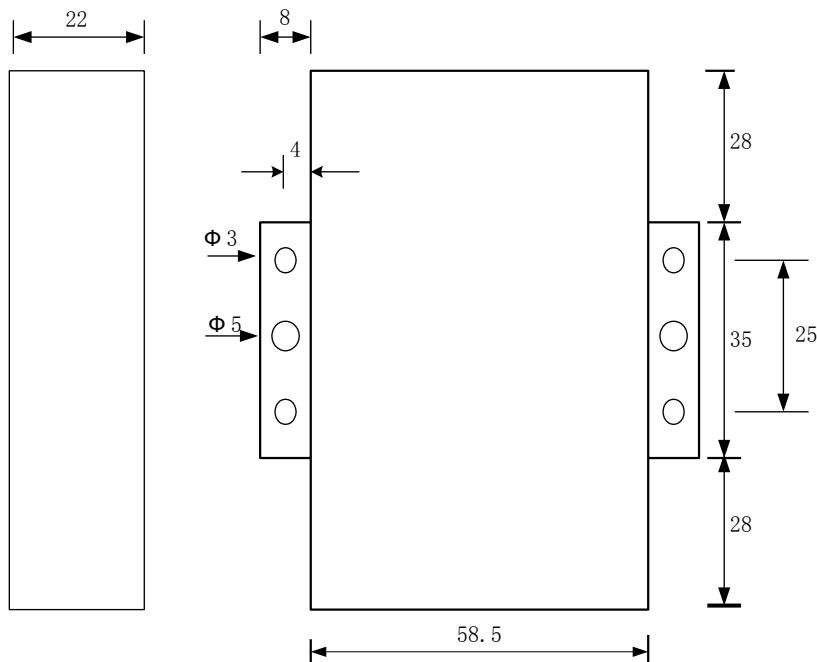

Installation of SIM/UIM card:

Firstly power off the IP MODEM, and press the out button of the SIM/UIM card outlet with a needle object. Then the SIM/UIM card sheath will flick out at once. Put SIM/UIM card into the card sheath (Pay attention to put the side which has metal point outside), and insert card sheath back to the SIM/UIM card outlet.

Warning: Forbid to install SIM/UIM card when powered!

Installation of antenna:

Screw the SMA male pin of the antenna to the female SMA outlet of the IP MODEM tightly.
Warning: The antenna must be screwed tightly, or the signal quality of antenna will be influenced!

Installation of cable:

Insert DB9F end of the RS232/RS485 data cable into the DB9M interface of IP MODEM, and connect the other end with user's device.

The signal connection of the RS232 data cable is as follows:

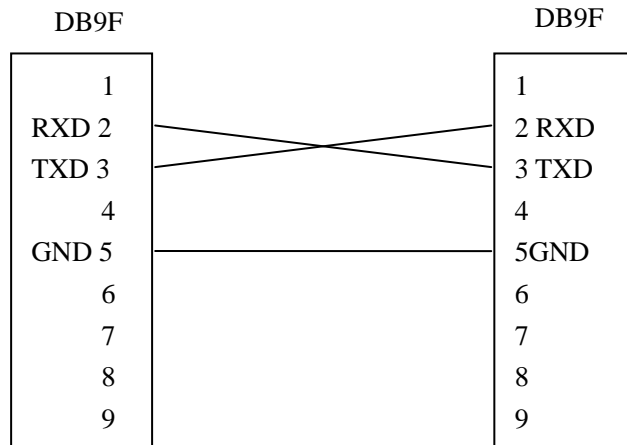

RS232 data cable

The signal connection of the RS485 data cable is as follows:

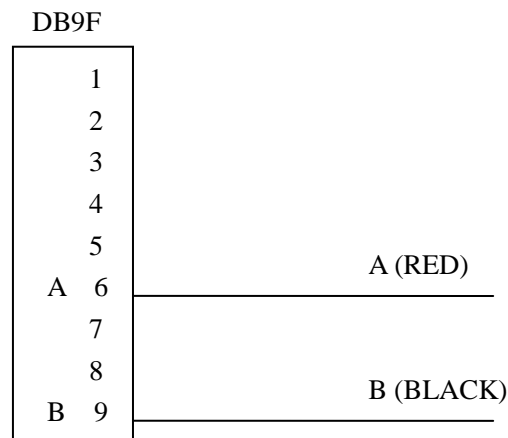

RS485 data cable

2.4 Power

The power range of the IP MODEM is DC 5~35V

Warning: When we use other power, we should make sure that the power can supply power above 4W.

We recommend user to use the standard DC 12V/0.5A power adaptor.

2.5 Indicator Lights Introduction

The IP MODEM provides three indicator lights: “Power”, “ACT”, “Online”.

Indicator Light	State	Introduction
Power	ON	IP MODEM is powered on
	OFF	IP MODEM is powered off
ACT	BLINK	Data is communicating
	OFF	No data
Online	ON	IP MODEM has logged on network
	OFF	IP MODEM hasn't logged on network

Chapter 3 Configuration

3.1 Configuration Connection

Before configuration, it's necessary to connect the IP MODEM with the configure PC by the shipped RS232 or RS232-485 conversion cable as following.

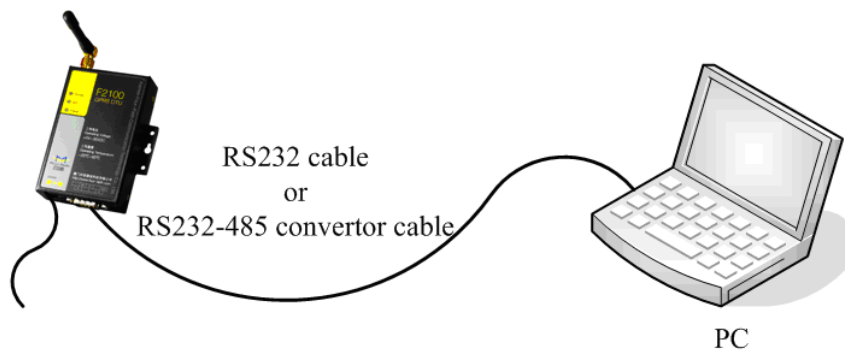

3.2 Enter Configure State

Run FfSmsIP MODEMConfig-En.exe configure tool, as following:

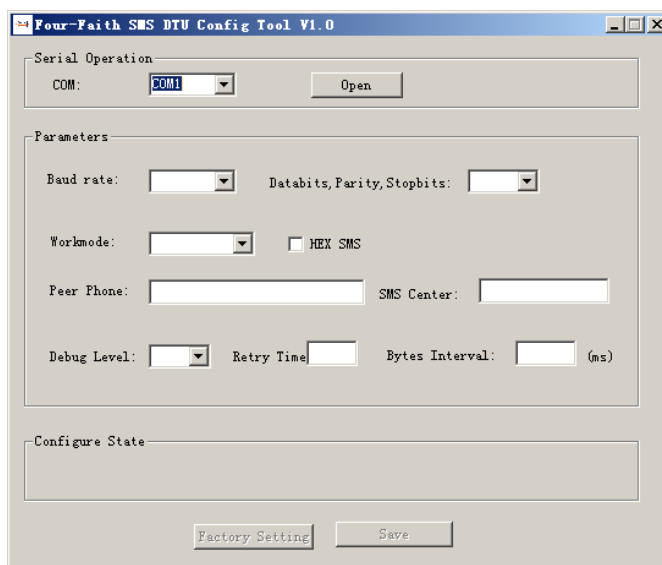

Click "Open" button, State column displays the following information, Software is waiting IP MODEM enter configure state.

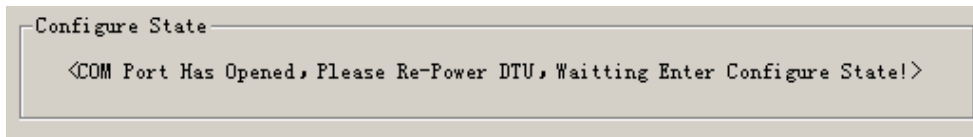

Re-power IP MODEM, Configure tool will make it enter configure state, and load its current settings.

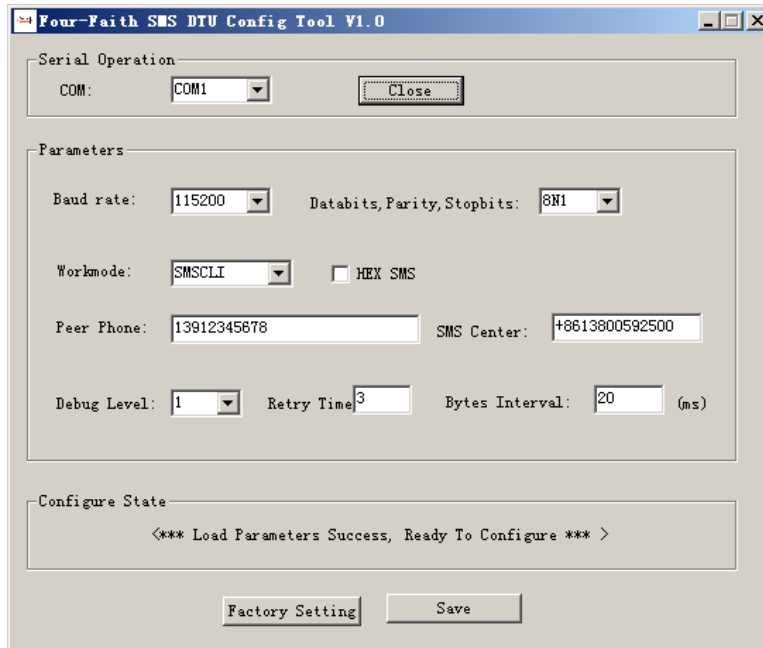

IP MODEM has been in configure state, It's ready for configuring its parameters.

3.3 Configuration

3.3.1 Serial Port Parameters

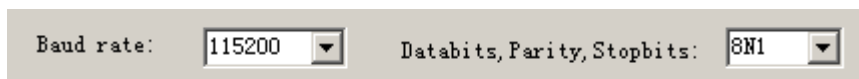

Baud rate

The serial port communication speed

AT Command:

AT+IPR=xxxx

xxxx: the speed value, such as 115200 ,57600 ,19200 ,etc

Databits, Parity, Stopbits

- 8N1: 8 databits, no parity, 1 stopbit
- 8E1: 8 databits, even parity, 1 stopbit
- 8O1: 8 databits, odd parity, 1 stopbit

AT Command:
 AT+SERMODE=xxx
 xxx: one of the above three choices

3.3.2 Workmode



According to different applications, IP MODEM can be configured to different work mode.

AT Command:
 AT+MODE=xxx
 xxx: workmode

TRNS

IP MODEM works as a common GSM MODEM.

SMSSER

This workmode is called SMS server mode. When IP MODEM receives SMS, it will read SMS and send out the SMS content to serial port. To send SMS, the SMS content should be encapsulated as the following format.

Head	phone_len	phone	data_len_high	data_len_low	data	tail
1 byte	1 byte	11 bytes	1 byte	1 byte		1 byte
0x02	11 (0x0b)	13666041237				0x03

head : frame header, fixed as 0x02 。
 phone_len :

Peer phone number length

- phone: Peer phone number
- data_len_high: SMS content length high byte
- data_len_low: SMS content length low byte

SMS content length should be: $data_len_high * 256 + data_len_low$.

data: SMS content

tail: frame tail, fixed as 0x03。

Example:

Send SMS content “hello” to 13912345678, the data format should be as following:

0x02 0x0b 0x31 0x33 0x39 0x31 0x32 0x33 0x34 0x35 0x36 0x37 0x38 0x00 0x05 0x68
0x65 0x6c 0x6c 0x6f 0x03

数据解析:

0x02: header

0x0b: Peer phone number length, It is 11 bytes

0x31...0x38: Peer phone number (13912345678)

0x00 0x05: SMS content length, It is 5 bytes

0x68 0x65 0x6c 0x6c 0x6f: SMS content “hello”

0x03: tail

SMSCLI

This mode is called SMS client mode, When IP MODEM receive SMS, it will read SMS and send out the SMS content to serial port. To send SMS, It’ s necessary to configure “Peer Phone” (refer 3. 2. 2. 4). When IP MODEM receives serial port data(SMS content), it will send to peer phone.

CSD

Circuit Switched Data communication

3.3.3 HEX SMS



In this mode, IP MODEM can send any characters(0x00 ~ 0xff) to peer phone, So, it can be used in industrial monitor applications.

AT Command:

AT+HEXSMS=x

x: 0 or 1 , 0 normal SMS, 1 HEX SMS

3.3.4 Peer Phone

Peer Phone:

This item is valid only when the workmode is SMSCLI, It can be configured at most five peer phone numbers, They are divided by comma.

Peer Phone:

AT Command:
AT+PHON=xxx
xxx: peer phone number

3.3.5 SMS Center

SMS Center:

SMS Center number of your ISP.

AT Command:
AT+SMSC=xxx
xxx: SMS Center number

3.3.6 Debug Level

Debug Level:

Debug level is used to control debug information, the default value is 1.

- 0 : No debug information output
- 1 : Simple prompt information
- 2 : Detail debug information

AT Command:
AT+DEBUG=x
x: the debug value

3.3.7 Retry Times



Retry Times

The maximum retry times if send SMS fail.

AT Command:

AT+RETRY=xxx

xxx: Retry times value

3.3.8 Bytes Interval

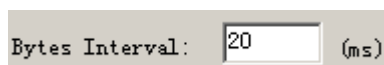

Bytes Interval: (ms)

The time interval used to determine whether the serial data frame transmission has completed, IP MODEM will send the serial data to peer phone when two bytes transmit time interval larger than this item value.

AT Command:

AT+BYTEINT=xxx

xxx: bytes interval value

Appendix

The following steps describe how to make IP MODEM enter configure state with the Windows XP Hyper Terminal.

1. Press “Start”→”Programs”→”Accessories”→”Communications”→”Hyper Terminal”



2. Input connection name, choose “OK”
3. Choose the correct COM port which connect to IP MODEM, choose “OK”



4. Configure the serial port parameters as following, choose “OK”

Bits per second: 115200
Data bits: 8
Parity: None
Stop bits: 1
Flow control: None

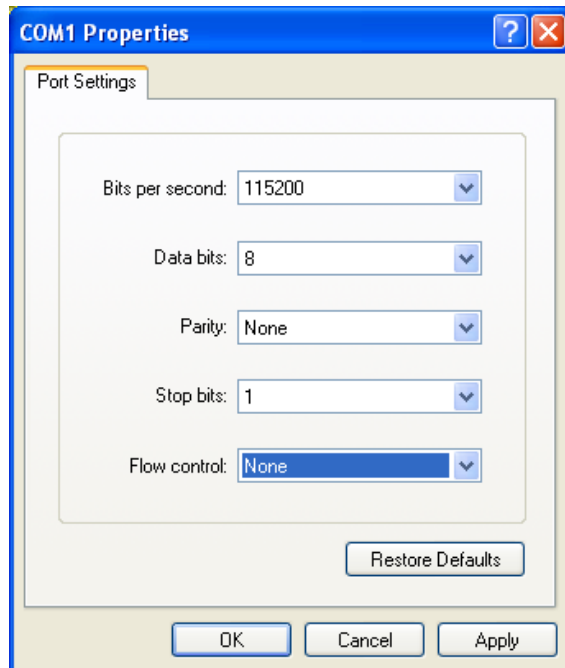

5. Complete Hyper Terminal operation, It runs as following

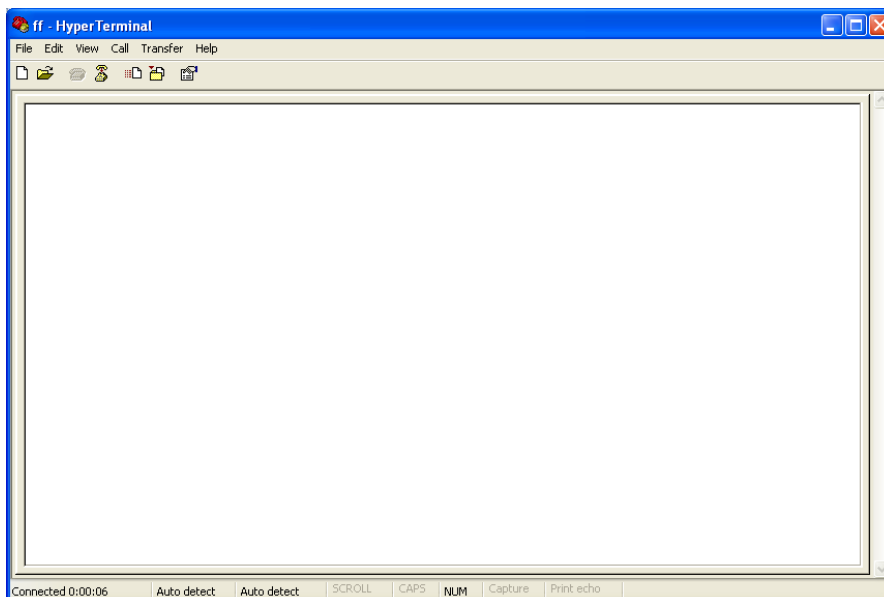

6. Re-power IP MODEM, put mouse focus on the Hyper Terminal and press “s” key
[Xiamen Four-Faith Communication Technology Co.,Ltd.](http://www.fourfaith.com)
Add: J1-J3,3rdFloor,No.44,GuanRiRoad,SoftWare Park,XiaMen .361008.China
http: //www.fourfaith.com Tel: +86 592-6300326 6300325 6300324 Fax: +86 592-5912735

continuously until IP MODEM enter configure state as following

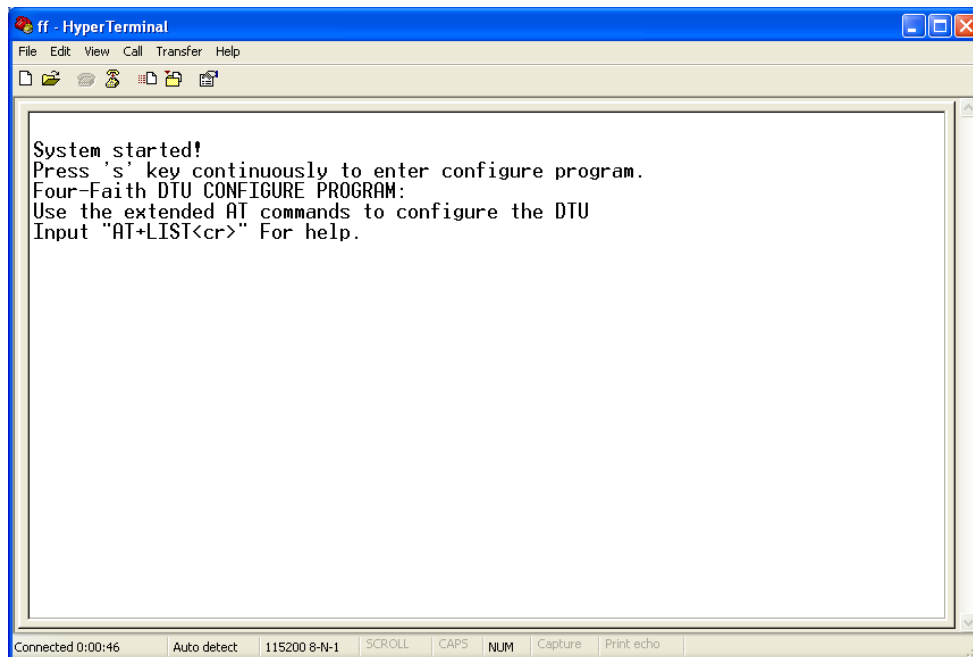

7. IP MODEM has entered configure state, you can configure the parameters through AT command.